

[This Drawing is a reproduction of the Original on a reduced scale.]

FIG. 1.

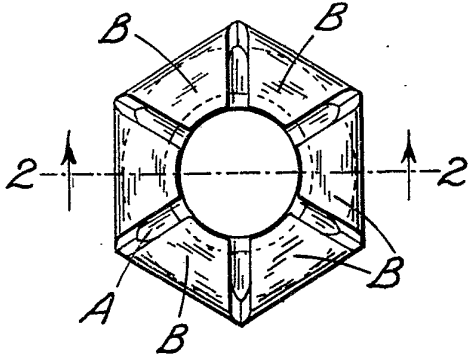

FIG. 3.

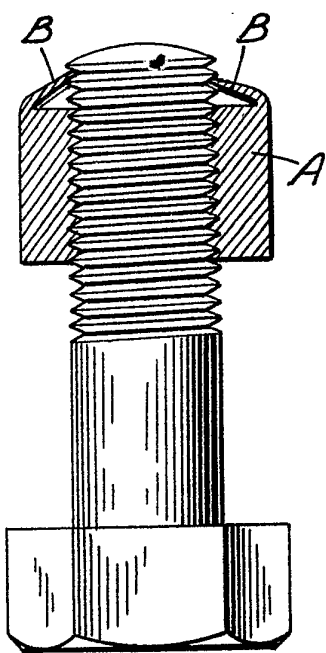

FIG. 2.

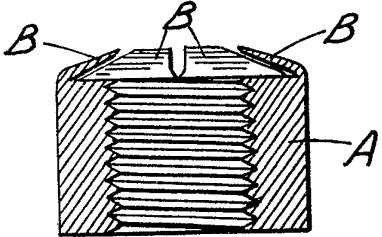

FIG. 4.

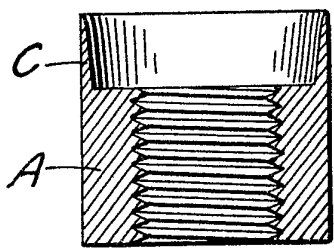

FIG. 5.

