

FIG.3

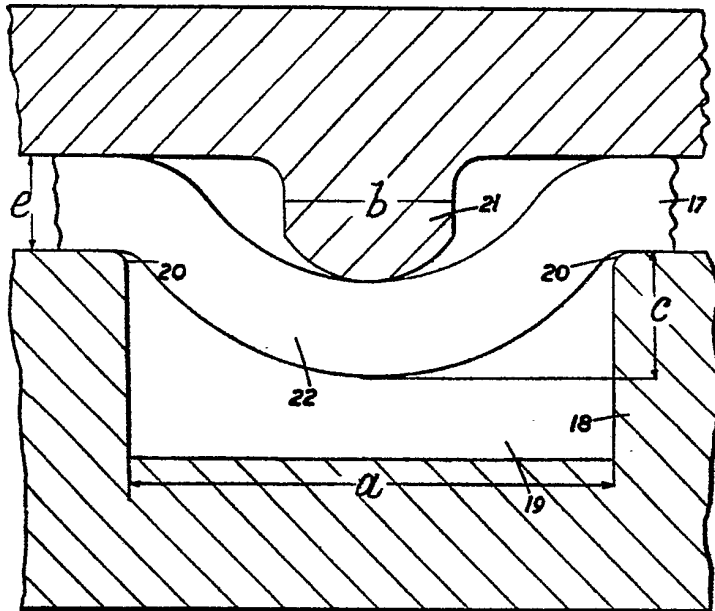

FIG.4

